

Strut profiles with 10 mm slot

The Rexroth modular profile system, with 10 mm slots in the modular dimensions 40 mm, 45 mm, 50 mm, and 60 mm, covers all conventional profile dimensions on the world market.

45 mm, and 50 mm, e.g. 50x50L) combine high strengths with minimum use of materials. This gives you a cost-effective and stable solution for the construction of tables, protection devices or frames, for instance.

Thanks to their computer-optimized design, the strut profiles L with 10 mm slot (modular dimensions 40 mm,

Slot, modular dimensions, central bore

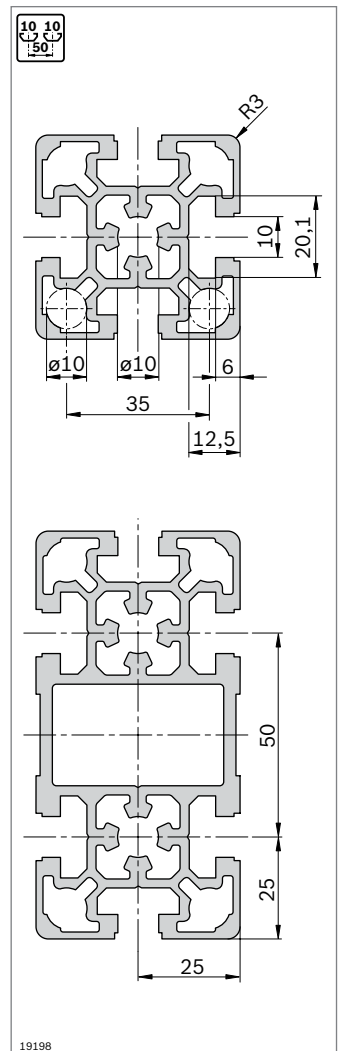
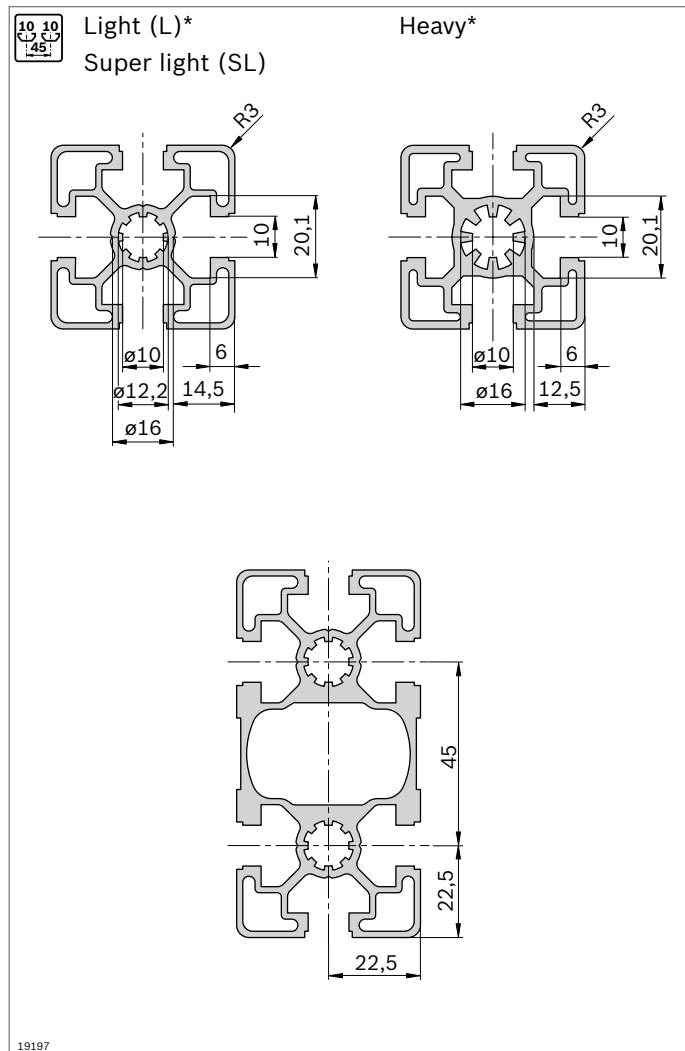
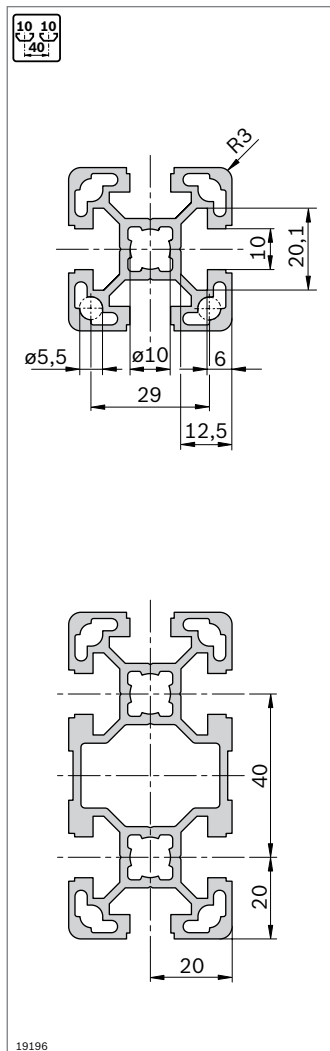

*) The following L-profiles have a "heavy" slot geometry:
45x90x90L; 45x90x90L 4N; 90x90L; 90x90L 4N; 90x90L 4NVS; 90x180L

Minimum profile lengths (mm) for Quick & Easy standard profile finishing on one or both sides

	-	M12	M16	D9.8	D17/DB17	F1
-	50	60	120	50	60	60
M12	60	110	180	90	90	110
M16	120	180	240	150	170	170
D9.8	50	90	150	80	70	90
D17/DB17	60	90	170	70	80	90
F1	60	110	170	90	90	80

For applications with high loads, we recommend especially stable profiles with 10 mm slots, e.g. for heavy work tables, fixtures, machine frames, transport shuttles, protective enclosures, and handling systems.

Due to its very sturdy design, this slot allows maximum strength connections.

Profile finishing

The diagram grid illustrates the following finishing methods and dimensions:

- D9.8:** Slot width p , diameter $\phi 9.8$, length $p/2$. ID: 00133811
- D17:** Slot width p , diameter $\phi 17$, length 22.5 . ID: 00133812
- DB17:** Slot width p , diameter $\phi 17$, length 22.5 . ID: 00133843
- M12:** Slot width p , diameter $\phi 12$, length 55 . ID: 00110837
- M16-D22:** Slot width p , diameter $\phi 22$, length 115 . ID: 00110839
- D28:** Slot width p , diameter $\phi 28$, length 33 . ID: 00110850
- M16:** Slot width p , diameter $\phi 16$, length 115 . ID: 00110838
- LF:** Slot width p , diameter $\phi 17$, length 22.5 . ID: 00110851
- LF-S:** Slot width p , diameter $\phi 17$, length 22.5 . ID: 00110852
- F1:** Slot width p , diameter $\phi 17$, length 18 . ID: 00133815
- F1/F1V:** Slot width p , diameter $\phi 17$, length 18 . ID: 00110848

45x45L

A = 6,0 cm²
 $I_x = 11,7 \text{ cm}^4$
 $I_y = 11,7 \text{ cm}^4$
 $W_x = 5,2 \text{ cm}^3$
 $W_y = 5,2 \text{ cm}^3$
 m = 1,6 kg/m

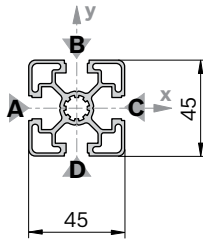

19421

Cover cap	Color	ESD	No.
45x45 (1x)	Signal gray		100 3 842 548 752
45x45 (1x)	Black		20 3 842 548 753
Material:	PP		

Cover cap with hole	Color	ESD	No.
45x45 (1x)	Signal gray		20 3 842 548 796
45x45 (1x)	Black		20 3 842 548 797
Material:	PP		

45x45L ON

A = 6,7 cm²
 $I_x = 13,5 \text{ cm}^4$
 $I_y = 13,5 \text{ cm}^4$
 $W_x = 6,0 \text{ cm}^3$
 $W_y = 6,0 \text{ cm}^3$
 m = 1,8 kg/m

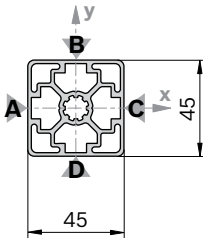

19422

Cover cap: see 45x45

45x45L	L (mm)	No.
1 pcs	50 ... 6000	3 842 992 425 / L
1 pcs M12	60 ... 6000	3 842 992 426 / L
1 pcs M12 M12	110 ... 6000	3 842 992 427 / L
1 pcs M12 D17	90 ... 6000	3 842 992 960 / L
1 pcs D9,8 D9,8	80 ... 6000	3 842 992 967 / L
1 pcs D17	60 ... 6000	3 842 992 953 / L
1 pcs D17 D17	80 ... 6000	3 842 992 954 / L
1 pcs D17 D17V	80 ... 6000	3 842 992 956 / L
20 pcs	6070	3 842 553 611

Quick & Easy (p. 2-8, see fold-out section)

45x45L	3 842 993 737 / ...
Length L (mm)	50 ... 6000
Standard profile finishing (note minimum length, p. 2-25)	M12 / D9,8 / D17 / DB17 / F1 (A) ¹⁾
Customized profile finishing (L _{max} = 5400 mm)	DI / DIS / MT / MTS / MI / MIS / DG ²⁾

¹⁾ For the specified slots

²⁾ DG_{max} = 45°; L_{min1} / L_{min2} = 378 / 456 mm

45x45L ON	L (mm)	No.
20 pcs	6070	3 842 540 955

Quick & Easy (p. 2-8, see fold-out section)

45x45L ON	3 842 993 761 / ...
Length L (mm)	50 ... 6000
Standard profile finishing (note minimum length, p. 2-25)	M12 / D9.8 / D17 / DB17
Customized profile finishing (L _{max} = 5400 mm)	DI / DIS / MT / MTS / MI / MIS / DG ¹⁾

¹⁾ DG_{max} = 45°; L_{min1} / L_{min2} = 378 / 456 mm

45x45L 1N

A = 6,5 cm²
 I_x = 12,6 cm⁴
 I_y = 13,5 cm⁴
 W_x = 5,5 cm³
 W_y = 6,0 cm³
 m = 1,8 kg/m

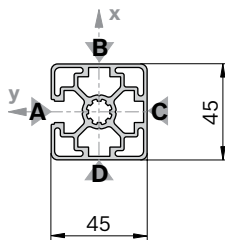

19423

Cover cap: see 45x45

45x45L 1N		L (mm)	No.
1 pcs		50 ... 5600	3 842 992 401 / L
20 pcs		5600	3 842 506 956

Quick & Easy (p. 2-8, see fold-out section)

45x45L 1N	3 842 993 738 / ...
Length L (mm)	50 ... 5600
Standard profile finishing (note minimum length, p. 2-25)	M12 / D9.8 / D17 / DB17
Customized profile finishing (L _{max} = 4900 mm)	DI / DIS / MT / MTS / MI / MIS / DG ¹⁾

¹⁾ DG_{max} = 45°; L_{min1} / L_{min2} = 378 / 456 mm

45x45L 2N

A = 6,4 cm²
 I_x = 11,6 cm⁴
 I_y = 13,5 cm⁴
 W_x = 5,2 cm³
 W_y = 6,0 cm³
 m = 1,7 kg/m

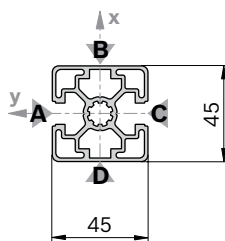

19424

Cover cap: see 45x45

45x45L 2N		L (mm)	No.
1 pcs		50 ... 5600	3 842 992 403 / L
20 pcs		5600	3 842 506 958

Quick & Easy (p. 2-8, see fold-out section)

45x45L 2N	3 842 993 739 / ...
Length L (mm)	50 ... 5600
Standard profile finishing (note minimum length, p. 2-25)	M12 / D9.8 / D17 / DB17
Customized profile finishing (L _{max} = 4900 mm)	DI / DIS / MT / MTS / MI / MIS / DG ¹⁾

¹⁾ DG_{max} = 45°; L_{min1} / L_{min2} = 378 / 456 mm

45x45L 2NVS

A = 6,4 cm²
 I_x = 12,6 cm⁴
 I_y = 12,6 cm⁴
 W_x = 5,6 cm³
 W_y = 5,6 cm³
 m = 1,7 kg/m

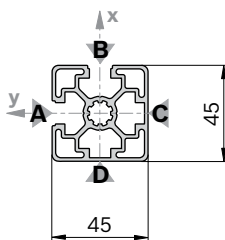

19425

Cover cap: see 45x45

45x45L 2NVS		L (mm)	No.
1 pcs		50 ... 5600	3 842 992 402 / L
20 pcs		5600	3 842 506 957

Quick & Easy (p. 2-8, see fold-out section)

45x45L 2NVS	3 842 993 740 / ...
Length L (mm)	50 ... 5600
Standard profile finishing (note minimum length, p. 2-25)	M12 / D9.8 / D17 / DB17
Customized profile finishing (L _{max} = 4900 mm)	DI / DIS / MT / MTS / MI / MIS / DG ¹⁾

¹⁾ DG_{max} = 45°; L_{min1} / L_{min2} = 378 / 456 mm

45x45L 3N

A = 6,2 cm²
 $I_x = 12,6 \text{ cm}^4$
 $I_y = 11,7 \text{ cm}^4$
 $W_x = 5,4 \text{ cm}^3$
 $W_y = 5,2 \text{ cm}^3$
 m = 1,7 kg/m

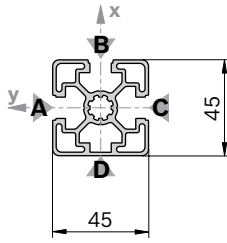

19426

Cover cap: see 45x45

45x45L 3N

L (mm) No.

1 pcs		50 ... 5600	3 842 992 404 / L
20 pcs		5600	3 842 506 959

Quick & Easy (p. 2-8, see fold-out section)

45x45L 3N

3 842 993 741 / ...

Length L (mm)	50 ... 5600
Standard profile finishing (note minimum length, p. 2-25)	M12 / D9.8 / D17 / DB17
Customized profile finishing ($L_{max} = 4900 \text{ mm}$)	DI / DIS / MT / MTS / MI / MIS / DG ¹⁾

¹⁾ DG_{max} = 45°; $L_{min1} / L_{min2} = 378 / 456 \text{ mm}$

45x30°

A = 6,9 cm²
 $I_x = 12,7 \text{ cm}^4$
 $I_y = 15,2 \text{ cm}^4$
 $W_x = 5,0 \text{ cm}^3$
 $W_y = 5,3 \text{ cm}^3$
 m = 1,9 kg/m

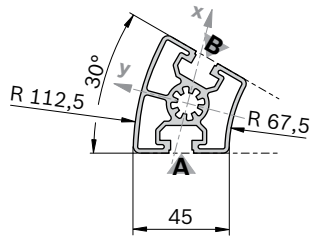

19427

45x30°

L (mm) No.

1 pcs		50 ... 5600	3 842 993 013 / L
20 pcs		5600	3 842 524 040

Quick & Easy (p. 2-8, see fold-out section)

45x30°

3 842 993 733 / ...

Length L (mm)	50 ... 5600
Standard profile finishing (note minimum length, p. 2-25)	M12
Customized profile finishing	—

Cover cap	Color	ESD		No.
45x30° (1x)	Signal gray		20	3 842 551 020
45x30° (1x)	Black		20	3 842 551 021

Material: PP

45x45°

A = 7,6 cm²
 $I_x = 13,4 \text{ cm}^4$
 $I_y = 21,4 \text{ cm}^4$
 $W_x = 5,2 \text{ cm}^3$
 $W_y = 6,4 \text{ cm}^3$
 m = 2,0 kg/m

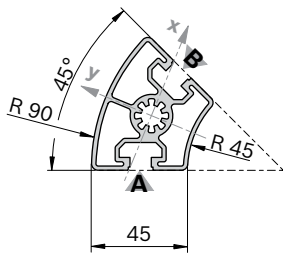

19428

45x45°

L (mm) No.

1 pcs		50 ... 5600	3 842 993 014 / L
20 pcs		5600	3 842 524 043

Quick & Easy (p. 2-8, see fold-out section)

45x45°

3 842 993 735 / ...

Length L (mm)	50 ... 5600
Standard profile finishing (note minimum length, p. 2-25)	M12
Customized profile finishing	—

Cover cap	Color	ESD		No.
45x45° (1x)	Signal gray		20	3 842 551 022
45x45° (1x)	Black		20	3 842 551 023

Material: PP

45x60°

A = 6,8 cm²
 I_x = 11,4 cm⁴
 I_y = 16,9 cm⁴
 W_x = 4,4 cm³
 W_y = 5,2 cm³
 m = 1,8 kg/m

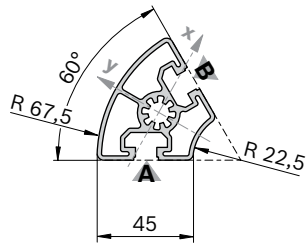

19429

Cover cap	Color	ESD	No.
45x60° (1x)	Signal gray		20 3 842 551 024
45x60° (1x)	Black		20 3 842 551 025

Material: PP

45x45L R

A = 4,9 cm²
 I_x = 8,6 cm⁴
 I_y = 8,6 cm⁴
 W_x = 5,0 cm³
 W_y = 5,0 cm³
 m = 1,3 kg/m

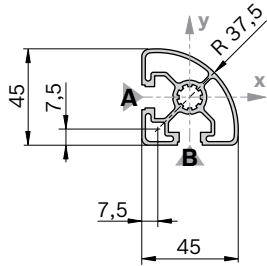

19430

Cover cap	Color	ESD	No.
45x45 R (1x)	Signal gray		20 3 842 548 800
45x45 R (1x)	Black		20 3 842 548 801

Material: PP

45x45 HR

A = 6,6 cm²
 I_x = 11,0 cm⁴
 I_y = 10,7 cm⁴
 W_x = 4,4 cm³
 W_y = 4,8 cm³
 m = 1,8 kg/m

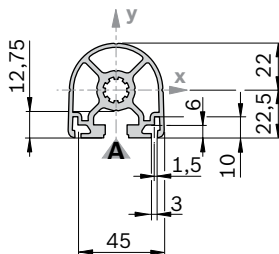

19431

Cover cap	Color	ESD	No.
45x45 HR (1x)	Signal gray		20 3 842 548 798
45x45 HR (1x)	Black		20 3 842 548 799

Material: PP

45x60°	L (mm)	No.
1 pcs	50 ... 5600	3 842 993 015 / L
20 pcs	5600	3 842 524 046

Quick & Easy (p. 2-8, see fold-out section)

45x60°	3 842 993 744 / ...
Length L (mm)	50 ... 5600
Standard profile finishing (note minimum length, p. 2-25)	M12
Customized profile finishing	–

45x45L R	L (mm)	No.
1 pcs	50 ... 5600	3 842 992 897 / L
20 pcs	5600	3 842 517 200

Quick & Easy (p. 2-8, see fold-out section)

45x45L R	3 842 993 742 / ...
Length L (mm)	50 ... 5600
Standard profile finishing (note minimum length, p. 2-25)	M12 / DB17
Customized profile finishing	–

45x45 HR	L (mm)	No.
1 pcs	50 ... 5600	3 842 992 945 / L
1 pcs M12	60 ... 5600	3 842 993 001 / L
1 pcs M12	110 ... 5600	3 842 992 999 / L
20 pcs	5600	3 842 525 505

Quick & Easy (p. 2-8, see fold-out section)

45x45 HR	3 842 993 736 / ...
Length L (mm)	50 ... 5600
Standard profile finishing (note minimum length, p. 2-25)	M12 / DB17
Customized profile finishing (L _{max} = 4900 mm)	DI / DIS / MT / MTS / MI / MIS / DG ¹⁾

¹⁾ DG_{max} = 45°; L_{min1} / L_{min2} = 378 / 456 mm

45x45

$A = 7,5 \text{ cm}^2$
 $I_x = 13,8 \text{ cm}^4$
 $I_y = 13,8 \text{ cm}^4$
 $W_x = 6,1 \text{ cm}^3$
 $W_y = 6,1 \text{ cm}^3$
 $m = 2,0 \text{ kg/m}$

10 10
45

19432

Cover cap	Color	ESD	No.
45x45 (1x)	Signal gray		100 3 842 548 752
45x45 (1x)	Black		20 3 842 548 753
Material:	PP		

Cover cap with hole	Color	ESD	No.
45x45 (1x)	Signal gray		20 3 842 548 796
45x45 (1x)	Black		20 3 842 548 797
Material:	PP		

45x45	L (mm)	No.
1 pcs	50 ... 6000	3 842 990 520 / L
1 pcs M12	60 ... 6000	3 842 990 517 / L
1 pcs M12 M12	110 ... 6000	3 842 990 518 / L
1 pcs M12 M16	180 ... 6000	3 842 990 519 / L
1 pcs M12 D17	90 ... 6000	3 842 990 640 / L
1 pcs M16	120 ... 6000	3 842 990 521 / L
1 pcs M16 D17	170 ... 6000	3 842 990 642 / L
1 pcs D9,8 D9,8	70 ... 6000	3 842 992 969 / L
1 pcs D17	60 ... 6000	3 842 990 648 / L
1 pcs D17 D17	80 ... 6000	3 842 990 644 / L
1 pcs D17 D17V	80 ... 6000	3 842 990 646 / L
20 pcs	6070	3 842 553 614

Quick & Easy (p. 2-8, see fold-out section)

45x45	3 842 993 734 / ...
Length L (mm)	50 ... 6000
Standard profile finishing (note minimum length, p. 2-25)	M12 / M16 / D9.8 / D17 / DB17
Customized profile finishing ($L_{\max} = 5400 \text{ mm}$)	DI / DIS / MT / MTS / MI / MIS / DG ¹⁾

¹⁾ $DG_{\max} = 45^\circ$; $L_{\min1} / L_{\min2} = 378 / 456 \text{ mm}$

45x60

$A = 11,0 \text{ cm}^2$
 $I_x = 37,2 \text{ cm}^4$
 $I_y = 22,7 \text{ cm}^4$
 $W_x = 12,4 \text{ cm}^3$
 $W_y = 10,1 \text{ cm}^3$
 $m = 3,0 \text{ kg/m}$

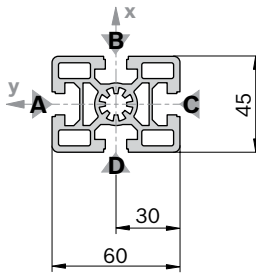

19433

Cover cap	Color	ESD	No.
45x60 (1x)	Signal gray		20 3 842 548 754
45x60 (1x)	Black		20 3 842 548 755

Material: PP

Cover cap with hole	Color	ESD	No.
45x60 (1x)	Signal gray		20 3 842 548 802
45x60 (1x)	Black		20 3 842 548 803

Material: PP

45x60	L (mm)	No.
1 pcs	50 ... 5600	3 842 990 570 / L
1 pcs M12	60 ... 5600	3 842 990 571 / L
1 pcs M12 M12	110 ... 5600	3 842 990 572 / L
1 pcs M12 M16	180 ... 5600	3 842 990 575 / L
1 pcs M16	120 ... 5600	3 842 990 573 / L
1 pcs D9,8	50 ... 5600	3 842 992 376 / L
1 pcs D17	60 ... 5600	3 842 990 688 / L
1 pcs D17 D17	80 ... 5600	3 842 990 672 / L
1 pcs D17 D17V	80 ... 5600	3 842 990 674 / L
1 pcs D9,8V	50 ... 5600	3 842 992 375 / L
1 pcs D17V	60 ... 5600	3 842 990 690 / L
1 pcs D17V D17V	90 ... 5600	3 842 990 670 / L
1 pcs LF LF	80 ... 5600	3 842 993 085 / L
1 pcs F1 F1	80 ... 5600	3 842 990 584 / L
20 pcs	5600	3 842 509 184

Profile finishing D9.8, D17: in slots B/D
 D9.8V, D17V: in slots A/C
 LF: in slots A/C
 F1: in slot A

Quick & Easy (p. 2-8, see fold-out section)

45x60	3 842 993 743 / ...
Length L (mm)	50 ... 5600
Standard profile finishing (note minimum length, p. 2-25)	M12 / M16 / D9.8 / D17 / DB17 / F1 (A,C) ¹⁾
Customized profile finishing (L _{max} = 4900 mm)	DI / DIS / MT / MTS / MI / MIS / DG ²⁾

¹⁾ For the specified slots

²⁾ DG_{max} = 45°; L_{min1} / L_{min2} = 404 / 508 mm

45x90SL

$A = 9,0 \text{ cm}^2$
 $I_x = 73,4 \text{ cm}^4$
 $I_y = 18,1 \text{ cm}^4$
 $W_x = 16,3 \text{ cm}^3$
 $W_y = 8,0 \text{ cm}^3$
 $m = 2,4 \text{ kg/m}$

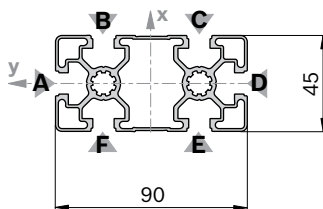

19434

Cover cap	Color	ESD	No.
45x90 (1x)	Signal gray		20 3 842 548 756
45x90 (1x)	Black		20 3 842 548 757

Material: PP

Cover cap with hole	Color	ESD	No.
45x90 (1x)	Signal gray		20 3 842 548 804
45x90 (1x)	Black		20 3 842 548 805

Material: PP

45x90SL	L (mm)	No.
1 pcs	50 ... 6000	3 842 993 450 / L
12 pcs	6070	3 842 537 102

Quick & Easy (p. 2-8, see fold-out section)

45x90SL	3 842 993 759 / ...
Length L (mm)	50 ... 6000
Standard profile finishing (note minimum length, p. 2-25)	M12 / D9.8 / D17 / DB17
Customized profile finishing (L _{max} = 5400 mm)	DI / DIS / DG ¹⁾

¹⁾ DG_{max} = 45°; L_{min1} / L_{min2} = 456 / 612 mm

45x90L

A = 11,3 cm²
 $I_x = 82,0 \text{ cm}^4$
 $I_y = 23,6 \text{ cm}^4$
 $W_x = 18,2 \text{ cm}^3$
 $W_y = 10,5 \text{ cm}^3$
 m = 3,0 kg/m

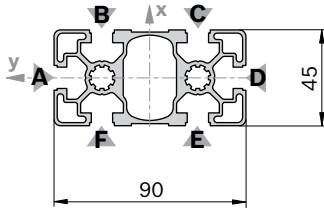

19435

Cover cap	Color	ESD	No.
45x90 (1x)	Signal gray		20 3 842 548 756
45x90 (1x)	Black		20 3 842 548 757

Material: PP

Cover cap with hole	Color	ESD	No.
45x90 (1x)	Signal gray		20 3 842 548 804
45x90 (1x)	Black		20 3 842 548 805

Material: PP

45x90L 2N

A = 12,0 cm²
 $I_x = 85,6 \text{ cm}^4$
 $I_y = 26,9 \text{ cm}^4$
 $W_x = 38,1 \text{ cm}^3$
 $W_y = 6,0 \text{ cm}^3$
 m = 3,2 kg/m

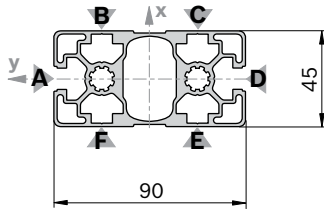

19436

Cover cap: see 45x90

45x90L	L (mm)	No.
1 pcs	50 ... 6000	3 842 992 432 / L
1 pcs M12	60 ... 6000	3 842 992 453 / L
1 pcs M12 M12	110 ... 6000	3 842 992 433 / L
1 pcs D17 D17	80 ... 6000	3 842 992 437 / L
1 pcs D17 D17V	80 ... 6000	3 842 992 436 / L
1 pcs D17V	60 ... 6000	3 842 992 452 / L
1 pcs D17V D17V	90 ... 6000	3 842 992 435 / L
1 pcs LF LF	80 ... 6000	3 842 993 084 / L
12 pcs	6070	3 842 553 612

Profile finishing: M12: in all core holes
 D17: in slots B/F, C/E
 D17V: in slots A/D
 LF: in slots A/D

Quick & Easy (p. 2-8, see fold-out section)

45x90L	3 842 993 662 / ...
Length L (mm)	50 ... 6000
Standard profile finishing (note minimum length, p. 2-25)	M12 / D9.8 / D17 / DB17 / F1 (A,D) ¹⁾
Customized profile finishing (L _{max} = 5400 mm)	DI / DIS / MT / MTS / MI / MIS / DG ²⁾

¹⁾ For the specified slots
²⁾ DG_{max} = 45°; L_{min1} / L_{min2} = 456 / 612 mm

45x90L 2N	L (mm)	No.
1 pcs	50 ... 6000	3 842 993 644 / L
12 pcs	6070	3 842 538 299

Quick & Easy (p. 2-8, see fold-out section)

45x90L 2N	3 842 993 751 / ...
Length L (mm)	50 ... 6000
Standard profile finishing (note minimum length, p. 2-25)	M12 / D9.8 / D17 / DB17 / F1 (A,D) ¹⁾
Customized profile finishing (L _{max} = 5400 mm)	DI / DIS / MT / MTS / MI / MIS / DG ²⁾

¹⁾ For the specified slots
²⁾ DG_{max} = 45°; L_{min1} / L_{min2} = 456 / 612 mm

45x90L 2NVS

$A = 12,0 \text{ cm}^2$
 $I_x = 25,9 \text{ cm}^4$
 $I_y = 90,6 \text{ cm}^4$
 $W_x = 5,7 \text{ cm}^3$
 $W_y = 40,3 \text{ cm}^3$
 $m = 3,3 \text{ kg/m}$

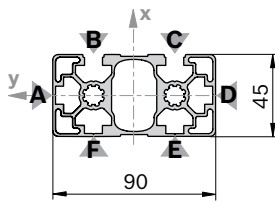

33096

Cover cap: see 45x90

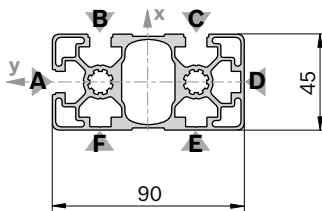

45x90L 3NVS

$A = 11,8 \text{ cm}^2$
 $I_x = 87,2 \text{ cm}^4$
 $I_y = 25,2 \text{ cm}^4$
 $W_x = 38,8 \text{ cm}^3$
 $W_y = 5,6 \text{ cm}^3$
 $m = 3,2 \text{ kg/m}$



19437



Cover cap: see 45x90

45x90L 2NVS		L (mm)	No.
	12 pcs		6070 3 842 555 652

Quick & Easy (p. 2-8; see fold-out section)

45x90L 2NVS		3 842 993 770 / ...
Length L (mm)		50 ... 6000
Standard profile finishing (note minimum length, p. 2-25)		M12 / D9.8 / D17 / DB17
Customized profile finishing ($L_{\max} = 5400 \text{ mm}$)		DI / DIS / MT / MTS / MI / MIS / DG ¹⁾

¹⁾ $DG_{\max} = 45^\circ$; $L_{\min 1} / L_{\min 2} = 456 / 612 \text{ mm}$

45x90L 3NVS		L (mm)	No.
	1 pcs		50 ... 6000 3 842 993 635 / L
	12 pcs		6070 3 842 538 298

Quick & Easy (p. 2-8, see fold-out section)

45x90L 3NVS		3 842 993 752 / ...
Length L (mm)		50 ... 6000
Standard profile finishing (note minimum length, p. 2-25)		M12 / D9.8 / D17 / DB17
Customized profile finishing ($L_{\max} = 5400 \text{ mm}$)		DI / DIS / MT / MTS / MI / MIS / DG ¹⁾

¹⁾ $DG_{\max} = 45^\circ$; $L_{\min 1} / L_{\min 2} = 456 / 612 \text{ mm}$

45x90

A = 15,4 cm²
 I_x = 124,6 cm⁴
 I_y = 32,8 cm⁴
 W_x = 27,7 cm³
 W_y = 14,6 cm³
 m = 4,2 kg/m

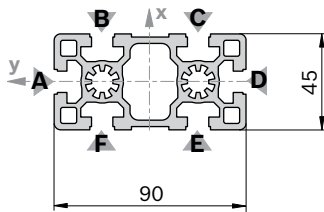

19438

Cover cap	Color	ESD	No.
45x90 (1x)	Signal gray		20 3 842 548 756
45x90 (1x)	Black		20 3 842 548 757

Material: PP

Cover cap with hole	Color	ESD	No.
45x90 (1x)	Signal gray		20 3 842 548 804
45x90 (1x)	Black		20 3 842 548 805

Material: PP

45x90	L (mm)	No.
1 pcs	50 ... 6000	3 842 990 300 / L
1 pcs M12	60 ... 6000	3 842 990 301 / L
1 pcs M12	110 ... 6000	3 842 990 302 / L
1 pcs M12	90 ... 6000	3 842 990 323 / L
1 pcs M12	90 ... 6000	3 842 990 305 / L
1 pcs M16	120 ... 6000	3 842 990 303 / L
1 pcs M16	240 ... 6000	3 842 990 304 / L
1 pcs M16	170 ... 6000	3 842 990 325 / L
1 pcs M16	170 ... 6000	3 842 990 307 / L
1 pcs D17	60 ... 6000	3 842 990 329 / L
1 pcs D17	80 ... 6000	3 842 990 313 / L
1 pcs D17	90 ... 6000	3 842 990 311 / L
1 pcs D17V	60 ... 6000	3 842 990 331 / L
1 pcs D17V	90 ... 6000	3 842 990 309 / L
12 pcs	6070	3 842 553 615

Profile finishing: M12, M16: in all core holes
 D17: in slots B/F, C/E
 D17V: in slots A/D

Quick & Easy (p. 2-8, see fold-out section)

45x90	3 842 993 661 / ...
Length L (mm)	50 ... 6000
Standard profile finishing (note minimum length, p. 2-25)	M12 / M16 / D9.8 / D17 / DB17 / F1 (A,D) ¹⁾
Customized profile finishing (L _{max} = 5400 mm)	DI / DIS / MT / MTS / MI / MIS / DG ²⁾

¹⁾ For the specified slots

²⁾ DG_{max} = 45°; L_{min1} / L_{min2} = 456 / 612 mm

45x180

A = 25,5 cm²
 I_x = 766,7 cm⁴
 I_y = 57,3 cm⁴
 W_x = 85,2 cm³
 W_y = 25,5 cm³
 m = 6,9 kg/m

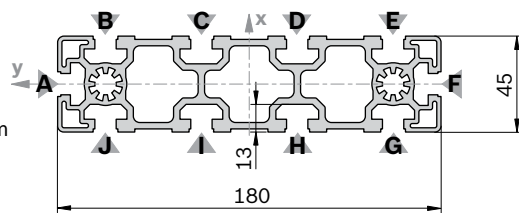

19439

Cover cap	Color	ESD	No.
45x180 (1x)	Signal gray		20 3 842 548 794
45x180 (1x)	Black		20 3 842 548 795

Material: PP

45x180	L (mm)	No.
1 pcs	50 ... 6000	3 842 990 335 / L
1 pcs M12	60 ... 6000	3 842 990 336 / L
1 pcs M12	110 ... 6000	3 842 990 339 / L
1 pcs D17	80 ... 6000	3 842 990 342 / L
1 pcs D17V	90 ... 6000	3 842 990 344 / L
6 pcs	6070	3 842 553 616

Profile finishing: M12: in all core holes
 D17: in slots B/J, E/G
 D17V: in slots A/F

Quick & Easy (p. 2-8, see fold-out section)

45x180	3 842 993 731 / ...
Length L (mm)	80 ... 6000
Standard profile finishing (note minimum length, p. 2-25)	M12 / M16 / D9.8 (B,C,D,E,G,H,I,J) ¹⁾ / D17 (B,C,D,E,G,H,I,J) ¹⁾ / DB17 / F1 (A,F) ¹⁾
Customized profile finishing (L _{max} = 5400 mm)	DI / DIS / MT / MTS / MI / MIS / DG ²⁾

¹⁾ For the specified slots

²⁾ DG_{max} = 30°; L_{min1} / L_{min2} = 404 / 508 mm

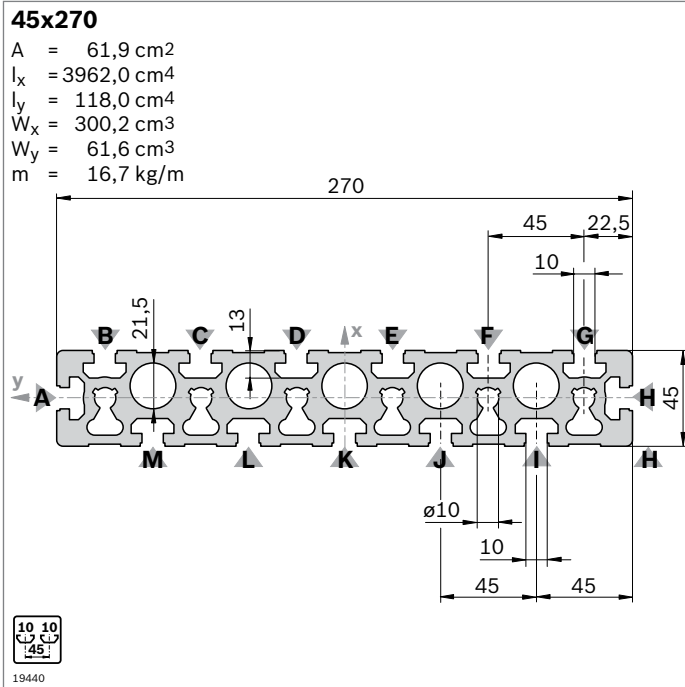

45x270	L (mm)	No.
1 pcs	50 ... 5600	3 842 992 927 / L
1 pcs M12	110 ... 5600	3 842 992 928 / L
2 pcs	5600	3 842 520 025

Profile finishing: M12: in core holes with C, F slots

Quick & Easy (p. 2-8, see fold-out section)

45x270	3 842 993 732 / ...
Length L (mm)	80 ... 5600
Standard profile finishing (note minimum length, p. 2-25)	M12 / D9.8 (B,C,D,E,F,G, I,J,K,L,M) ¹⁾ / D17 (B,C,D,E,F,G,I,J,K,L,M) ¹⁾ / DB17 / F1 (A,H) ¹⁾
Customized profile finishing (L _{max} = 4900 mm)	DI / DIS / MT / MTS / MI / MIS

¹⁾ For the specified slots

Cover cap	Color	ESD	No.
45x90 (3x)	Signal gray	20	3 842 548 756
45x90 (3x)	Black	20	3 842 548 757

Material: PP

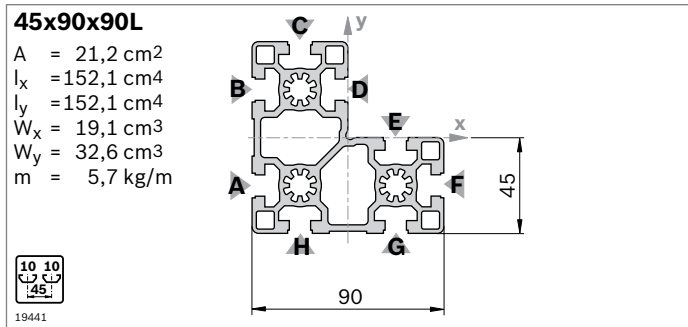

45x90x90L	L (mm)	No.
1 pcs	50 ... 6000	3 842 992 387 / L
1 pcs M12	60 ... 6000	3 842 992 388 / L
8 pcs	6070	3 842 537 823

Profile finishing: M12: in the central bore at the intersection of slots A and H

Quick & Easy (p. 2-8; see fold-out section)

45x90x90L	3 842 993 682 / ...
Length L (mm)	50 ... 6000
Standard profile finishing (note minimum length, p. 2-25)	M12 / D9.8 / D17 / DB17 (A,B,C,F,G,H) ¹⁾
Customized profile finishing (L _{max} = 5400 mm)	DI / DIS / MT / MTS / MI / MIS / DG ²⁾

¹⁾ For the specified slots

²⁾ DG_{max} = 45°; L_{min1} / L_{min2} = 456 / 612 mm

Cover cap	Color	ESD	No.
45x90x90 (1x)	Signal gray	20	3 842 548 806
45x90x90 (1x)	Black	20	3 842 548 807

Material: PP

Cap with hole ¹⁾	Color	ESD	No.
45x90x90 (1x)	Signal gray	20	3 842 548 806
45x90x90 (1x)	Black	20	3 842 548 807

Material: PP

¹⁾The cover cap is also suitable for use with a hole, which can be broken out

45x90x90L 4N

$A = 22,1 \text{ cm}^2$
 $I_x = 160,8 \text{ cm}^4$
 $I_y = 160,8 \text{ cm}^4$
 $W_x = 30,6 \text{ cm}^3$
 $W_y = 30,6 \text{ cm}^3$
 $m = 6,0 \text{ kg/m}$

10 10
145

29432

Cover cap: see 45x90x90L

90x90SL

$A = 14,1 \text{ cm}^2$
 $I_x = 130,2 \text{ cm}^4$
 $I_y = 130,2 \text{ cm}^4$
 $W_x = 28,9 \text{ cm}^3$
 $W_y = 28,9 \text{ cm}^3$
 $m = 3,8 \text{ kg/m}$

10 10
145

19442

Cover cap: see 90x90L

90x90L

$A = 24,1 \text{ cm}^2$
 $I_x = 211,1 \text{ cm}^4$
 $I_y = 211,1 \text{ cm}^4$
 $W_x = 46,9 \text{ cm}^3$
 $W_y = 46,9 \text{ cm}^3$
 $m = 6,5 \text{ kg/m}$

10 10
145

19443

Cover cap	Color	ESD	No.
90x90L (1x)	Signal gray		20 3 842 548 758
90x90L (1x)	Black		20 3 842 548 759
Material:	PP		

45x90x90L 4N	L (mm)	No.
8 pcs	6070	3 842 547 827

Quick & Easy (p. 2-8, see fold-out section)

45x90x90L 4N	3 842 993 764
Length L (mm)	50 ... 6070
Standard profile finishing (note minimum length, p. 2-25)	M12 / D9.8 / D17 / DB17 (A,B,C,F,G,H) ¹⁾
Customized profile finishing ($L_{\max} = 5400 \text{ mm}$)	DI / DIS / MT / MTS / MI / MIS / DG ²⁾

¹⁾ For the specified slots

²⁾ $DG_{\max} = 45^\circ$; $L_{\min1} / L_{\min2} = 456 / 612 \text{ mm}$

90x90SL	L (mm)	No.
1 pcs	50 ... 6000	3 842 993 449 / L
6 pcs	6070	3 842 537 100

Quick & Easy (p. 2-8, see fold-out section)

90x90SL	3 842 993 681 / ...
Length L (mm)	50 ... 6000
Standard profile finishing (note minimum length, p. 2-25)	M12 / D9.8 / D17 / DB17
Customized profile finishing ($L_{\max} = 5400 \text{ mm}$)	DI / DIS / DG ¹⁾

¹⁾ $DG_{\max} = 45^\circ$; $L_{\min1} / L_{\min2} = 456 / 612 \text{ mm}$

90x90L	L (mm)	No.
1 pcs	50 ... 6000	3 842 992 415 / L
1 pcs M12	60 ... 6000	3 842 992 416 / L
1 pcs M12 M12	110 ... 6000	3 842 992 422 / L
1 pcs M12 D17	90 ... 6000	3 842 992 423 / L
1 pcs D17	60 ... 6000	3 842 992 417 / L
1 pcs D17 D17	80 ... 6000	3 842 992 420 / L
1 pcs D17 D17V	80 ... 6000	3 842 992 421 / L
1 pcs LF LF	80 ... 6000	3 842 992 418 / L
1 pcs LF M12	90 ... 6000	3 842 992 419 / L
6 pcs	6070	3 842 553 613

Profile finishing:

- M12: in all core holes
- D17: in slots C/H, D/G
- D17V: in slots A/F, B/E
- LF: in slots C/H, D/G

Quick & Easy (p. 2-8, see fold-out section)

90x90L	3 842 993 680 / ...
Length L (mm)	50 ... 6000
Standard profile finishing (note minimum length, p. 2-25)	M12 / D9.8 / D17 / DB17
Customized profile finishing ($L_{\max} = 5400 \text{ mm}$)	DI / DIS / MT / MTS / MI / MIS / DG ¹⁾

¹⁾ $DG_{\max} = 45^\circ$; $L_{\min1} / L_{\min2} = 456 / 612 \text{ mm}$

90x90L 4N

A = 24,2 cm²
 I_x = 227,4 cm⁴
 I_y = 214,7 cm⁴
 W_x = 50,5 cm³
 W_y = 47,7 cm³
 m = 6,5 kg/m



19444

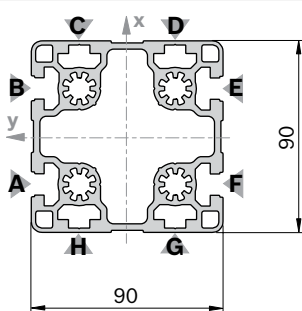

Cover cap: see 90x90L

90x90L 4N		L (mm)	No.
1 pcs		50 ... 6000	3 842 993 628 / L
6 pcs		6070	3 842 538 297

Quick & Easy (p. 2-8, see fold-out section)

90x90L 4N		3 842 993 755 / ...
Length L (mm)	50 ... 5600	
Standard profile finishing (note minimum length, p. 2-25)	M12 / D9.8 / D17 / DB17	
Customized profile finishing (L _{max} = 4900 mm)	DI / DIS / MT / MTS / MI / MIS / DG ¹⁾	

¹⁾ DG_{max} = 45°; L_{min1} / L_{min2} = 456 / 612 mm

90x90L 4NVS

A = 24,2 cm²
 I_x = 220,9 cm⁴
 I_y = 220,9 cm⁴
 W_x = 49,2 cm³
 W_y = 49,2 cm³
 m = 6,5 kg/m



19445

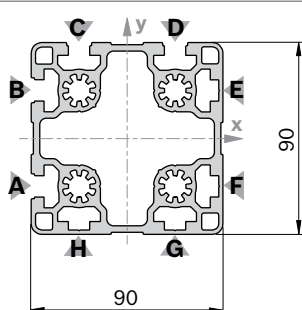

Cover cap: see 90x90L

90x90L 4NVS		L (mm)	No.
1 pcs		50 ... 6000	3 842 993 621 / L
6 pcs		6070	3 842 538 296

Quick & Easy (p. 2-8, see fold-out section)

90x90L 4NVS		3 842 993 756 / ...
Length L (mm)	50 ... 5600	
Standard profile finishing (note minimum length, p. 2-25)	M12 / D9.8 / D17 / DB17	
Customized profile finishing (L _{max} = 4900 mm)	DI / DIS / MT / MTS / MI / MIS / DG ¹⁾	

¹⁾ DG_{max} = 45°; L_{min1} / L_{min2} = 456 / 612 mm

90x90

A = 38,4 cm²
 I_x = 299,8 cm⁴
 I_y = 299,8 cm⁴
 W_x = 66,7 cm³
 W_y = 66,7 cm³
 m = 10,4 kg/m



19446

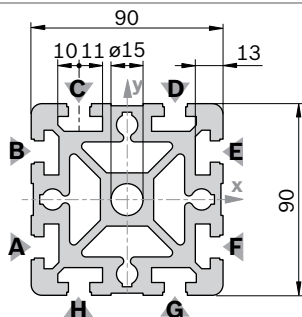

Cover cap	Color	ESD		No.
90x90 (1x)	Signal gray		20	3 842 548 760
90x90 (1x)	Black		20	3 842 548 761

Material: PP

Cover cap with hole	Color	ESD		No.
90x90 (1x)	Signal gray		20	3 842 548 814
90x90 (1x)	Black		20	3 842 548 815

Material: PP

Note: A quick connector cannot be used

90x90		L (mm)	No.
1 pcs		50 ... 5600	3 842 990 500 / L
1 pcs	M16	120 ... 5600	3 842 990 501 / L
1 pcs	M16 M16	240 ... 5600	3 842 990 502 / L
1 pcs	M16 D17	170 ... 5600	3 842 992 961 / L
1 pcs	M16/D22	60 ... 5600	3 842 992 373 / L
1 pcs	M16/D22 M16/D22	120 ... 5600	3 842 993 083 / L
1 pcs	D17	60 ... 5600	3 842 990 092 / L
1 pcs	D17 D17	80 ... 5600	3 842 990 093 / L
1 pcs	D17 D17V	80 ... 5600	3 842 990 094 / L
1 pcs	LF LF	80 ... 5600	3 842 993 082 / L
1 pcs	F2	60 ... 5600	3 842 990 505 / L
1 pcs	F2 F2	110 ... 5600	3 842 990 507 / L
6 pcs		5600	3 842 509 189

Quick & Easy (p. 2-8, see fold-out section)

90x90		3 842 993 679 / ...
Length L (mm)	50 ... 5600	
Standard profile finishing (note minimum length, p. 2-25)	M16 / D9.8 / D17 / DB17 / F1	
Customized profile finishing (L _{max} = 4900 mm)	DI / DIS / MT / MTS / MI / MIS / DG ¹⁾	

¹⁾ DG_{max} = 45°; L_{min1} / L_{min2} = 456 / 612 mm

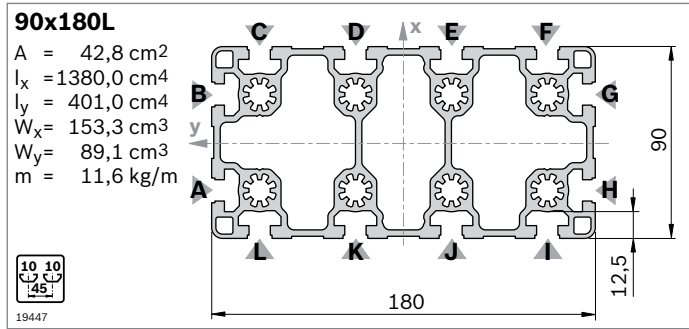

Cover cap	Color	ESD	No.
90x90L (2x)	Signal gray		20 3 842 548 758
90x90L (2x)	Black		20 3 842 548 759

Material: PP

90x180L	L (mm)	No.
1 pcs	50 ... 5600	3 842 992 857 / L
1 pcs M12	60 ... 5600	3 842 992 858 / L
1 pcs M12 M12	110 ... 5600	3 842 992 859 / L
1 pcs M1 LF	90 ... 5600	3 842 992 860 / L
1 pcs D17V D17V	90 ... 5600	3 842 992 864 / L
1 pcs LF LF	80 ... 5600	3 842 992 861 / L
3 pcs	5600	3 842 516 015

Profile finishing: M12: in all core holes
 D17V: in slots A/H, B/G
 LF: in slots A/H, B/G

Quick & Easy (p. 2-8, see fold-out section)

90x180L	3 842 993 677 / ...
Length L (mm)	80 ... 5600
Standard profile finishing (note minimum length, p. 2-25)	M12 / D9.8 (C,D,E,F,I, J,K,L) ¹⁾ / D17 (C,D,E,F,I,J, K,L) ¹⁾ / DB17 / F1 (A,G) ¹⁾
Customized profile finishing (L _{max} = 4900 mm)	DI / DIS / MT / MTS / MI / MIS / DG ²⁾

¹⁾ For the specified slots

²⁾ DG_{max} = 30°; L_{min1} / L_{min2} = 404 / 508 mm

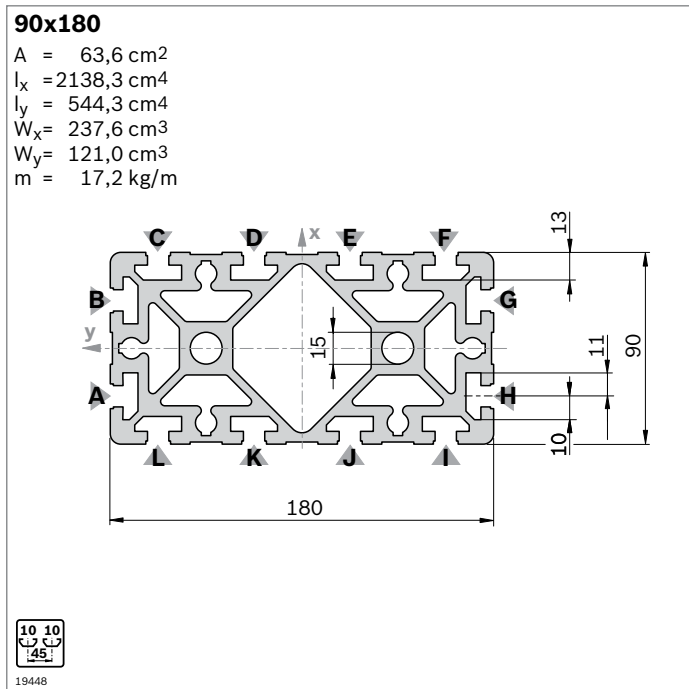

Cover cap	Color	ESD	No.
90x90 (2x)	Signal gray		20 3 842 548 760
90x90 (2x)	Black		20 3 842 548 761

Material: PP

Cover cap with hole	Color	ESD	No.
90x90 (2x)	Signal gray		20 3 842 548 814
90x90 (2x)	Black		20 3 842 548 815

Material: PP

90x180	L (mm)	No.
1 pcs	50 ... 6000	3 842 990 416 / L
1 pcs M16	120 ... 6000	3 842 990 417 / L
1 pcs M16 M16	240 ... 6000	3 842 990 418 / L
1 pcs M16 F2	170 ... 6000	3 842 990 419 / L
1 pcs D17V D17V	90 ... 6000	3 842 992 378 / L
1 pcs LF LF	80 ... 6000	3 842 992 898 / L
1 pcs LF-S LF-S	80 ... 6000	3 842 993 081 / L
1 pcs F2 F2	110 ... 6000	3 842 990 421 / L
3 pcs	6070	3 842 553 617

Profile finishing: M16: in all core holes
 D17V: in slots A/H, B/G
 LF: in slots A/H, B/G
 LF-S: in slots D/K, E/J

Quick & Easy (p. 2-8, see fold-out section)

90x180	3 842 993 676 / ...
Length L (mm)	80 ... 6000
Standard profile finishing (note minimum length, p. 2-25)	M16 / D9.8 (C,D,E,F,I,J, K,L) ¹⁾ / D17 (C,D,E,F,I,J, K,L) ¹⁾ / DB17 / F1 (A,G) ¹⁾
Customized profile finishing (L _{max} = 5400 mm)	DI / DIS / MT / MTS / MI / MIS / DG ²⁾

¹⁾ For the specified slots

²⁾ DG_{max} = 30°; L_{min1} / L_{min2} = 404 / 508 mm

Note: A quick connector cannot be used with profile 90x180

90x360

A = 90,2 cm²
 I_x = 14065,0 cm⁴
 I_y = 710,0 cm⁴
 W_x = 781,4 cm³
 W_y = 157,7 cm³
 m = 24,4 kg/m



19449

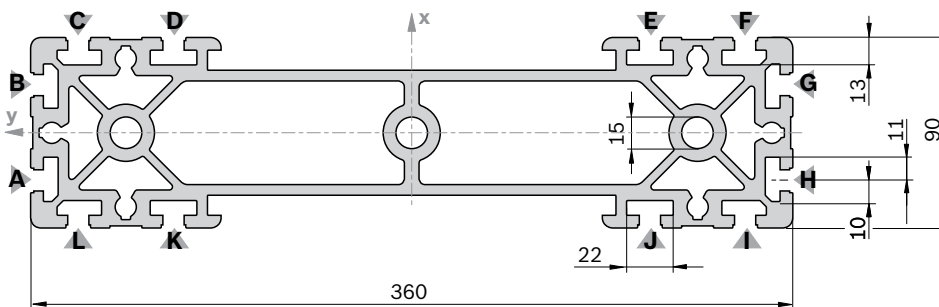

Cover cap	Color	ESD	No.
90x90 (2x)	Signal gray		20 3 842 548 760
90x90 (2x)	Black		20 3 842 548 761
Material:	PP		

Cover cap with hole	Color	ESD	No.
90x90 (2x)	Signal gray		20 3 842 548 814
90x90 (2x)	Black		20 3 842 548 815
Material:	PP		

Note: A quick connector cannot be used

90x360	L (mm)	No.
	50 ... 6000	3 842 993 434
M16	M16 240 ... 6000	3 842 993 435 / L
F2	F2 110 ... 6000	3 842 993 436 / L

Profile finishing: M16: in all core holes

Quick & Easy (p. 2-8, see fold-out section)

90x360	No.
	3 842 993 678 / ...
Length L (mm)	80 ... 6000
Standard profile finishing (note minimum length, p. 2-25)	M16 / D9.8 (C,D,E,F,I,J, K,L) ¹⁾ / D17 (C,D,E,F,I,J, K,L) ¹⁾ / DB17 / F1 (A,G) ¹⁾
Customized profile finishing (L _{max} = 5400 mm)	DI / DIS / MT / MTS / MI / MIS

¹⁾ For the specified slots

15x22,5

A = 1,3 cm²
 I_x = 0,8 cm⁴
 I_y = 0,3 cm⁴
 W_x = 0,9 cm³
 W_y = 0,6 cm³
 m = 0,3 kg/m



19450

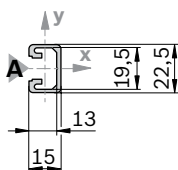

Cover cap	Color	ESD	No.
15x22.5 (1x)	Signal gray		20 3 842 548 816
15x22.5 (1x)	Black		20 3 842 548 817
Material:	PP		

15x22.5	L (mm)	No.
1 pcs	50 ... 3000	3 842 992 473 / L
1 pcs D17	60 ... 3000	3 842 992 474 / L
1 pcs D17	D17 80 ... 3000	3 842 992 475 / L
10 pcs	2000	3 842 513 576

Quick & Easy (p. 2-8, see fold-out section)

15x22.5	No.
	3 842 993 689 / ...
Length L (mm)	50 ... 2000
Standard profile finishing (note minimum length, p. 2-25)	D9.8 / D17
Customized profile finishing	—

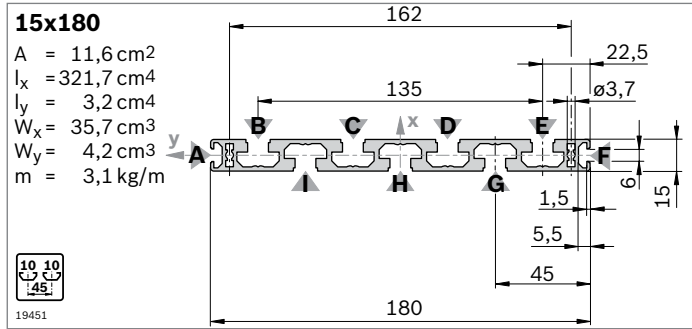

Cover cap	Color	ESD	No.
15x180 (1x)	Signal gray		20 3 842 548 772
15x180 (1x)	Black		20 3 842 548 773

Material: PP

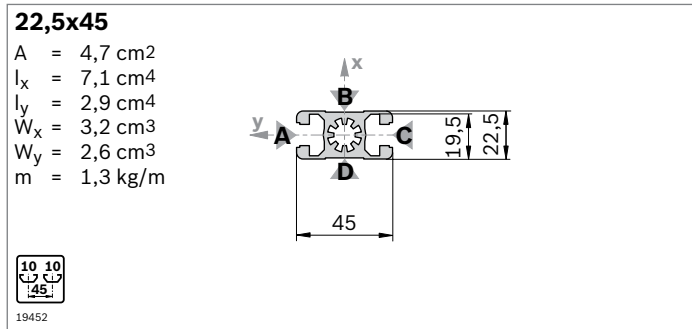

Cover cap	Color	ESD	No.
22,5x45 (1x)	Signal gray		20 3 842 548 830
22,5x45 (1x)	Black		20 3 842 548 831

Material: PP

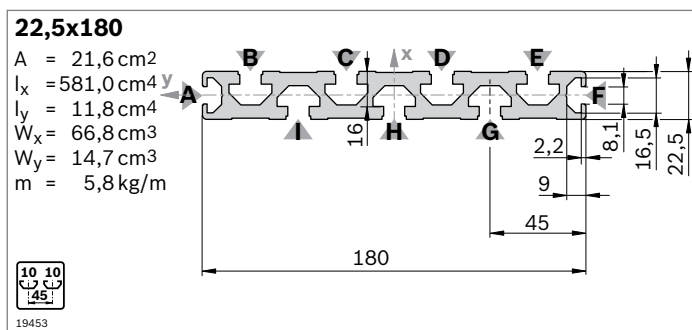

Cover cap	Color	ESD	No.
22,5x180 (1x)	Signal gray		20 3 842 548 770
22,5x180 (1x)	Black		20 3 842 548 771

Material: PP

15x180	L (mm)	No.
1 pcs	50 ... 5600	3 842 993 079 / L
6 pcs	5600	3 842 526 821

Quick & Easy (p. 2-8, see fold-out section)

15x180	No.
Length L (mm)	80 ... 5600
Standard profile finishing (note minimum length, p. 2-25)	D9.8 (B,C,D,E,G,H,I) ¹⁾ / D17 (B,C,D,E,G,H,I) ¹⁾
Customized profile finishing (L _{max} = 4900 mm)	DI / DIS / MT / MTS / MI / MIS

¹⁾ For the specified slots

22,5x45	L (mm)	No.
1 pcs	50 ... 6000	3 842 990 292 / L
1 pcs M12	60 ... 6000	3 842 990 087 / L
1 pcs M12 M12	110 ... 6000	3 842 990 090 / L
1 pcs D17V D17V	80 ... 6000	3 842 990 091 / L
24 pcs	6070	3 842 537 812

Quick & Easy (p. 2-8, see fold-out section)

22,5x45	No.
Length L (mm)	50 ... 6000
Standard profile finishing (note minimum length, p. 2-25)	M12 / D9.8 (A,C) ¹⁾ / D17 / DB17 (A,C) ¹⁾
Customized profile finishing (L _{max} = 5400 mm)	DI / DIS / MT / MTS / MI / MIS / DG ²⁾

¹⁾ For the specified slots

²⁾ DG_{max} = 45°; L_{min1} / L_{min2} = 378 / 456 mm

22,5x180	L (mm)	No.
1 pcs	50 ... 5600	3 842 990 345 / L
1 pcs D28	60 ... 5600	3 842 990 346 / L
1 pcs D28 D28	110 ... 5600	3 842 990 347 / L
6 pcs	5600	3 842 509 179

Profile finishing: D28: in slots G, I

Quick & Easy (p. 2-8, see fold-out section)

22,5x180	No.
Length L (mm)	80 ... 5600
Standard profile finishing (note minimum length, p. 2-25)	D9.8 (B,C,D,E,G,H,I) ¹⁾ / D17 (B,C,D,E,G,H,I) ¹⁾
Customized profile finishing (L _{max} = 4900 mm)	DI / DIS / MT / MTS / MI / MIS

¹⁾ For the specified slots